

Lift&Drive 225PRX

Technical data sheet

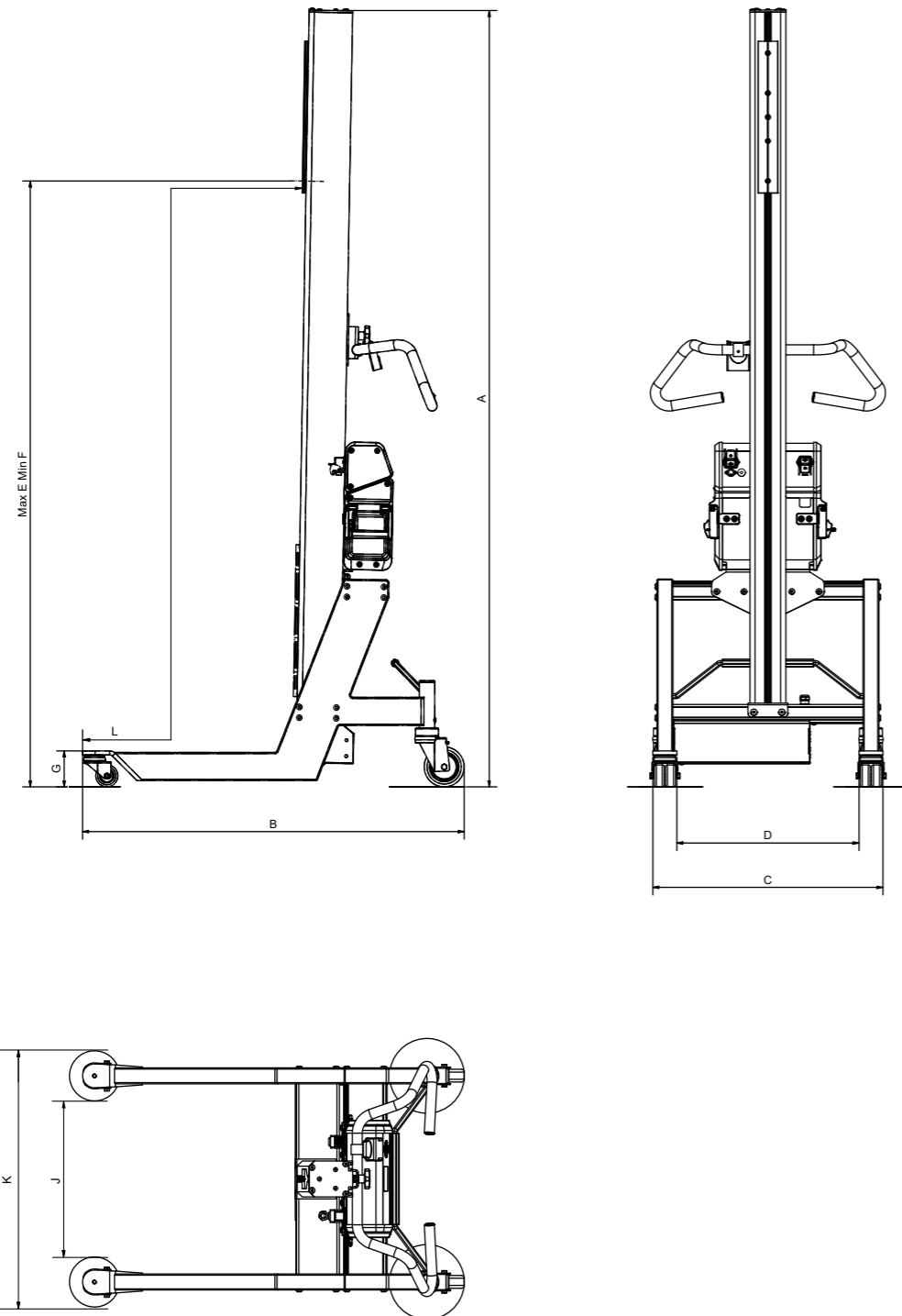

Dimensions



Model *	A	B	C	D	E	F	G	J	K	L
225PRX (mm)	2000	990	578	454	1568	308	142	339	693	529
225PRX, low castors (mm)	1948	956	590	440	1516	256	90	391	641	528

* Base model as standard column, legs, and cross member. The table shows theoretical measurements.

Technical data

Description	Lift&Drive 225PRX
Net weight (kg)*	62
Maximum load including tool at 400 mm from column (kg)	225
Max lifting speed empty (mm/s)	65
Weight load ratio	0,28
Stainless steel option	Yes
Min turning radius* (Ø mm)	1098
Safety approvals	CE

Battery options

Battery types	LiFePO4 or VRLA AGM
Nominal battery voltage (VDC)	24
Battery capacities (Ah)	10 LiFePO4 12 AGM, 17 AGM,

Charger

Charger options (A)	1.5 or 4
Max charge voltage (VDC)	29
Nominal input voltage (VAC)	100-240 ±10%
Available plugs with charger	Plug Type A – North America Plug Type C – Europe Plug Type G – UK Plug Type I – AU / NZ
Safety - Charger 1.5A	CE, cCSAus, IEC EN 60601-1, IEC EN 60601-1-2
Safety - Charger 4A	CE, UL, CSA

* Lowest net weight, no tool, Li battery
** Performance under optimal circumstances

Load capacity

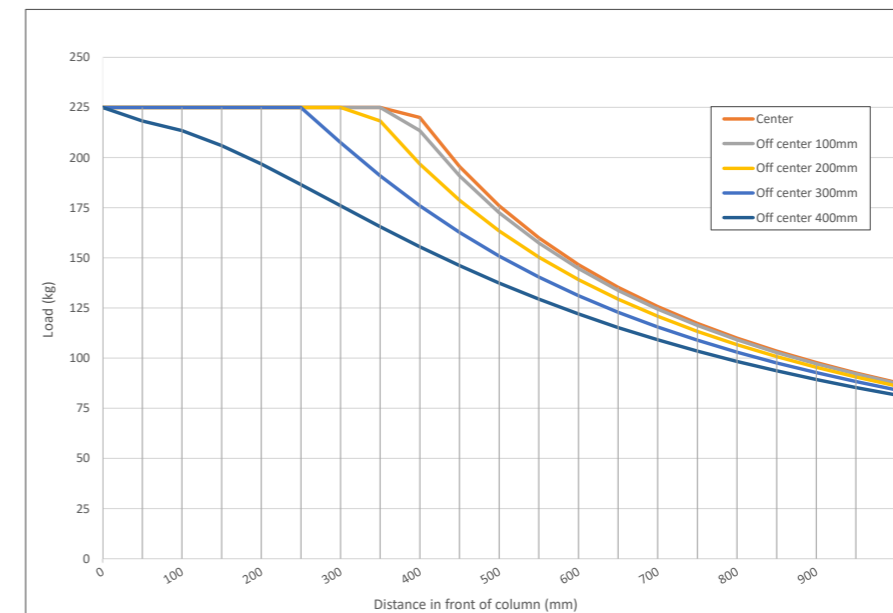

Available tools and accessories

Tools	Accessories
Prong	Holder for battery charger
Expand&Turn	
Squeeze&Turn	
Turn	
Option: Bespoke tools	

Smart moves
For safe work

Disclaimer. We reserve the right to make changes. Illustrations, drawings and data are not always in accordance with the latest version or standard model in production. The models in the pictures may present special equipment or colours.

PRONOMIC AB
Phone: +468 544706 60
sales@pronomic.com | pronomic.com